

# HB-240F2

LED high bay light 240W 31000lm

## Features

- ETL DLC CE Listed.
- Standard by IP65/Wet location
- 130lm/w
- 5 Years Warranty

## Parameter

Model No.:	HB-240F2
Power Consumption:	240W
Input Voltage:	100-277Vac 50/60Hz
LED Type	350pcs SMD3030
Lumens Output:	31000lm
CRI	70+
Color Temperature:	3000K, 4000K, 5000K,5700K
Beam Angle:	60° , 90° ,120°
Power Factor:	>0.95
IP Rating	IP65 / Wet location
Working Temp.:	-20° C ~ 50° C
Storage Temp.:	-40° C ~ 70° C
Finish:	Black
Housing:	Aluminum
Diffuser:	Tempered Glass
Installation:	Hanging
IK Rating:	IK08
Fixture Weight:	5.4kg(11.9lb)
Lifespan(L70):	>80,000 Hours



Intertek  
5006572



## Photometric

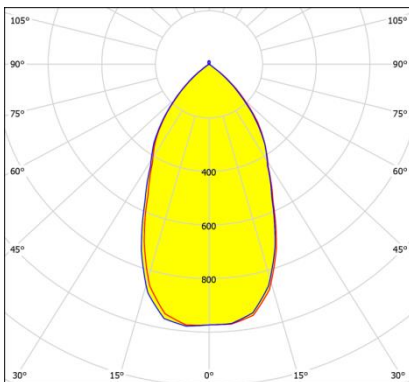

60° Aluminum Reflector

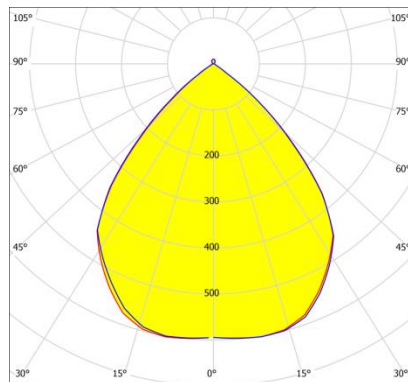

90° Aluminum Reflector

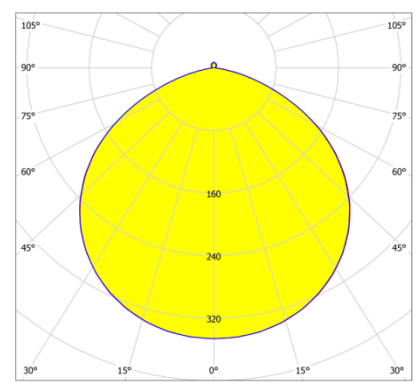

Without Reflector

## Dimension & Picture

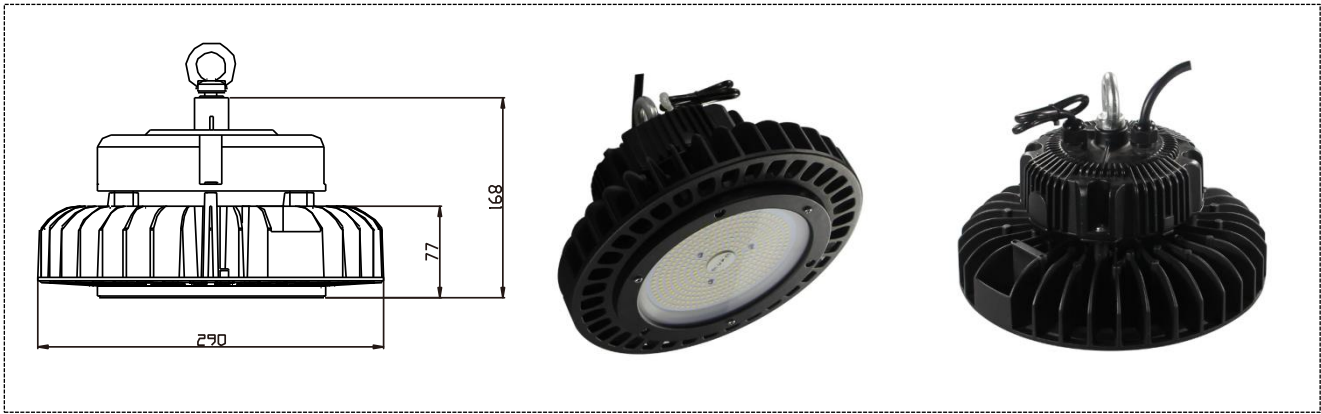

## Ordering Information

Sample: HB-240F2(5000K)

Product	Voltage	CCT	Operation
<b>HB-240F2</b> 240W	<b>Blank</b> 100-277Vac	<b>(3000K)</b> 3000K <b>(4000K)</b> 4000K <b>(5000K)</b> 5000K <b>(5700K)</b> 5700K	<b>Blank</b> no dimming <b>ADIM</b> 1-10V dimming <b>DALI</b> DALI dimming

- Finish: Black (other Finish, please call us for quotation)

## Accessories Optional

		
60° Aluminum Reflector	90° Aluminum Reflector	60° PC Reflector
HB-F2-ALU60D	HB-F2-ALU90D	HB-F2-PC60D

## Packaging

Item	Q'ty/CTN	G. W.	CTN Size
HB-240F2	1	6.5kg(14.3lb)	36x36x20cm(91.5"x91.5"x50.8")

## Container Loading QTY

Item	20'GP	40'GP	40'HQ

